

Quartus II Introduction Using Schematic Design

This tutorial presents an introduction to the Quartus[®] II CAD system. It gives a general overview of a typical CAD flow for designing circuits that are implemented by using FPGA devices, and shows how this flow is realized in the Quartus II software. The design process is illustrated by giving step-by-step instructions for using the Quartus II software to implement a very simple circuit in an Altera FPGA device.

The Quartus II system includes full support for all of the popular methods of entering a description of the desired circuit into a CAD system. This tutorial makes use of the schematic design entry method, in which the user draws a graphical diagram of the circuit. Two other versions of this tutorial are also available, which use the Verilog and VHDL hardware description languages, respectively.

The last step in the design process involves configuring the designed circuit in an actual FPGA device. To show how this is done, it is assumed that the user has access to the Altera DE1 Development and Education board connected to a computer that has Quartus II software installed. A reader who does not have access to the DE1 board will still find the tutorial useful to learn how the FPGA programming and configuration task is performed.

The screen captures in the tutorial were obtained using the Quartus II version 9.0; if other versions of the software are used, some of the images may be slightly different.

Contents:

Typical CAD Flow

Getting Started

Starting a New Project

Schematic Design Entry

Compiling the Design

Pin Assignment

Simulating the Designed Circuit

Programming and Configuring the FPGA Device

Testing the Designed Circuit

Computer Aided Design (CAD) software makes it easy to implement a desired logic circuit by using a programmable logic device, such as a field-programmable gate array (FPGA) chip. A typical FPGA CAD flow is illustrated in Figure 1.

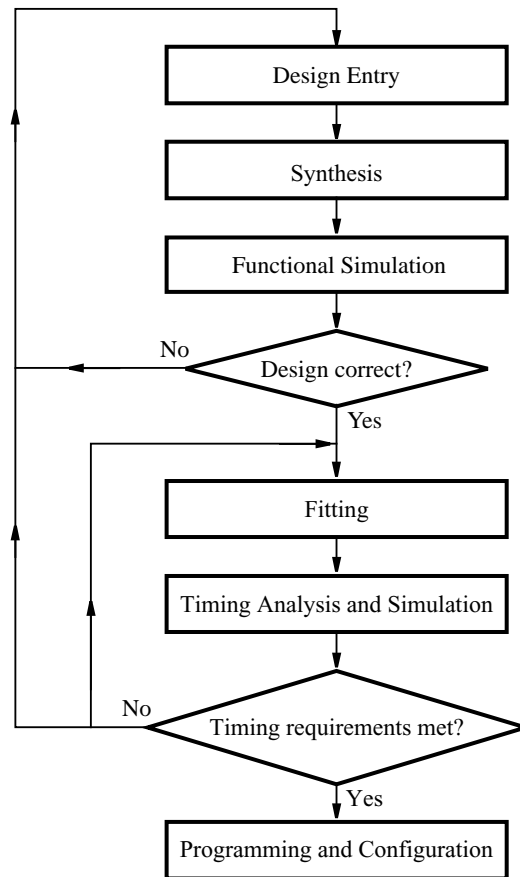

Figure 1. Typical CAD flow.

The CAD flow involves the following steps:

- **Design Entry** – the desired circuit is specified either by means of a schematic diagram, or by using a hardware description language, such as Verilog or VHDL
- **Synthesis** – the entered design is synthesized into a circuit that consists of the logic elements (LEs) provided in the FPGA chip
- **Functional Simulation** – the synthesized circuit is tested to verify its functional correctness; this simulation does not take into account any timing issues

- **Fitting** – the CAD Fitter tool determines the placement of the LEs defined in the netlist into the LEs in an actual FPGA chip; it also chooses routing wires in the chip to make the required connections between specific LEs
- **Timing Analysis** – propagation delays along the various paths in the fitted circuit are analyzed to provide an indication of the expected performance of the circuit
- **Timing Simulation** – the fitted circuit is tested to verify both its functional correctness and timing
- **Programming and Configuration** – the designed circuit is implemented in a physical FPGA chip by programming the configuration switches that configure the LEs and establish the required wiring connections

This tutorial introduces the basic features of the Quartus II software. It shows how the software can be used to design and implement a circuit specified by means of a schematic diagram. It makes use of the graphical user interface to invoke the Quartus II commands. Doing this tutorial, the reader will learn about:

- Creating a project
- Entering a schematic diagram
- Synthesizing a circuit from the schematic diagram
- Fitting a synthesized circuit into an Altera FPGA
- Assigning the circuit inputs and outputs to specific pins on the FPGA
- Simulating the designed circuit
- Programming and configuring the FPGA chip on Altera's DE1 board

1 Getting Started

Each logic circuit, or subcircuit, being designed with Quartus II software is called a *project*. The software works on one project at a time and keeps all information for that project in a single directory (folder) in the file system. To begin a new logic circuit design, the first step is to create a directory to hold its files. To hold the design files for this tutorial, we will use a directory *introtutorial*. The running example for this tutorial is a simple circuit for two-way light control.

Start the Quartus II software. You should see a display similar to the one in Figure 2. This display consists of several windows that provide access to all the features of Quartus II software, which the user selects with the computer mouse. Most of the commands provided by Quartus II software can be accessed by using a set of menus that are located below the title bar. For example, in Figure 2 clicking the left mouse button on the menu named **File** opens the menu shown in Figure 3. Clicking the left mouse button on the entry **Exit** exits from Quartus II software. In general, whenever the mouse is used to select something, the *left* button is used. Hence we will not normally specify which button to press. In the few cases when it is necessary to use the *right* mouse button, it will be specified explicitly.

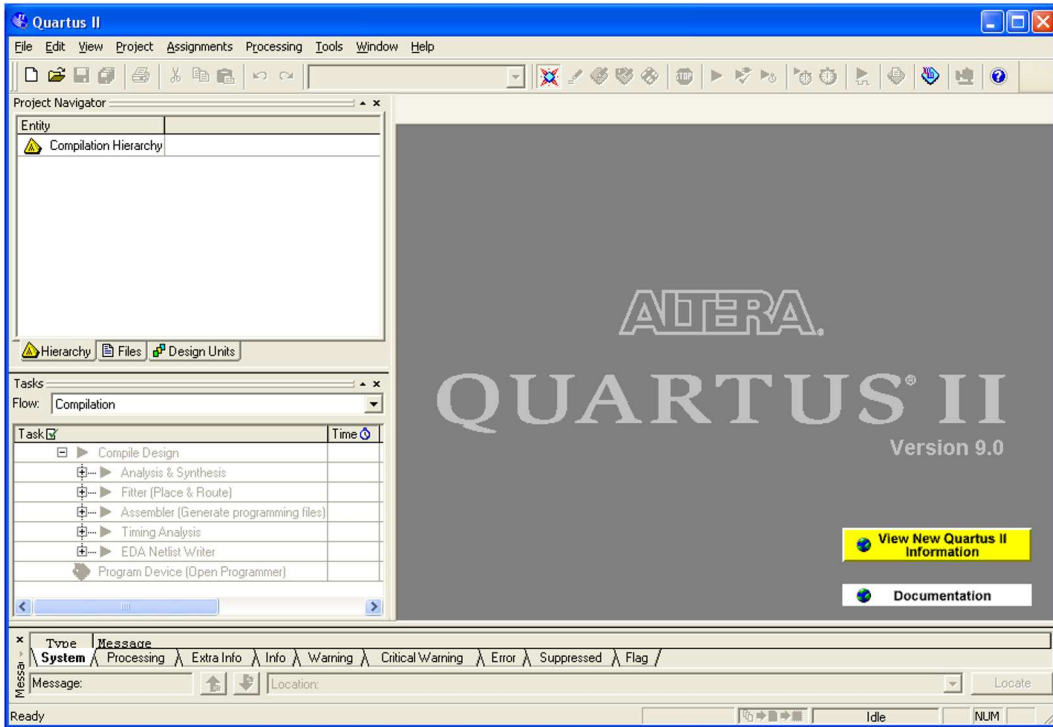

Figure 2. The main Quartus II display.

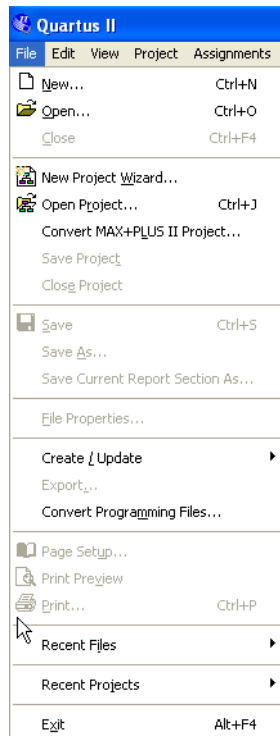

Figure 3. An example of the File menu.

For some commands it is necessary to access two or more menus in sequence. We use the convention **Menu1 > Menu2 > Item** to indicate that to select the desired command the user should first click the left mouse button on **Menu1**, then within this menu click on **Menu2**, and then within **Menu2** click on **Item**. For example, **File > Exit** uses the mouse to exit from the system. Many commands can be invoked by clicking on an icon displayed in one of the toolbars. To see the command associated with an icon, position the mouse over the icon and a tooltip will appear that displays the command name.

1.1 Quartus II Online Help

Quartus II software provides comprehensive online documentation that answers many of the questions that may arise when using the software. The documentation is accessed from the **Help** menu. To get some idea of the extent of documentation provided, it is worthwhile for the reader to browse through the **Help** menu. For instance, selecting **Help > How to Use Help** gives an indication of what type of help is provided.

The user can quickly search through the Help topics by selecting **Help > Search**, which opens a dialog box into which keywords can be entered. Another method, context-sensitive help, is provided for quickly finding documentation for specific topics. While using most applications, pressing the **F1** function key on the keyboard opens a Help display that shows the commands available for the application.

2 Starting a New Project

To start working on a new design we first have to define a new *design project*. Quartus II software makes the designer's task easy by providing support in the form of a *wizard*. Create a new project as follows:

1. Select **File > New Project Wizard** to reach the window in Figure 4, which asks for the name and directory of the project.

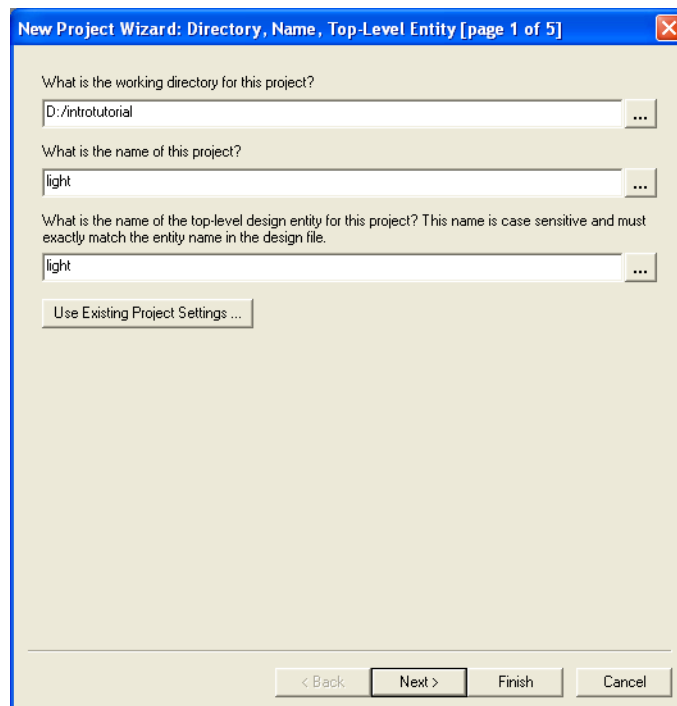

Figure 4. Creation of a new project.

2. Set the working directory to be *introtutorial*; of course, you can use some other directory name of your choice if you prefer. The project must have a name, which is usually the same as the top-level design entity that will be included in the project. Choose *light* as the name for both the project and the top-level entity, as shown in Figure 4. Press **Next**. Since we have not yet created the directory *introtutorial*, Quartus II software displays the pop-up box in Figure 5 asking if it should create the desired directory. Click **Yes**, which leads to the window in Figure 6.

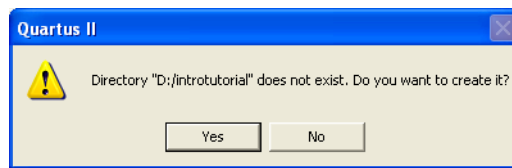

Figure 5. Quartus II software can create a new directory for the project.

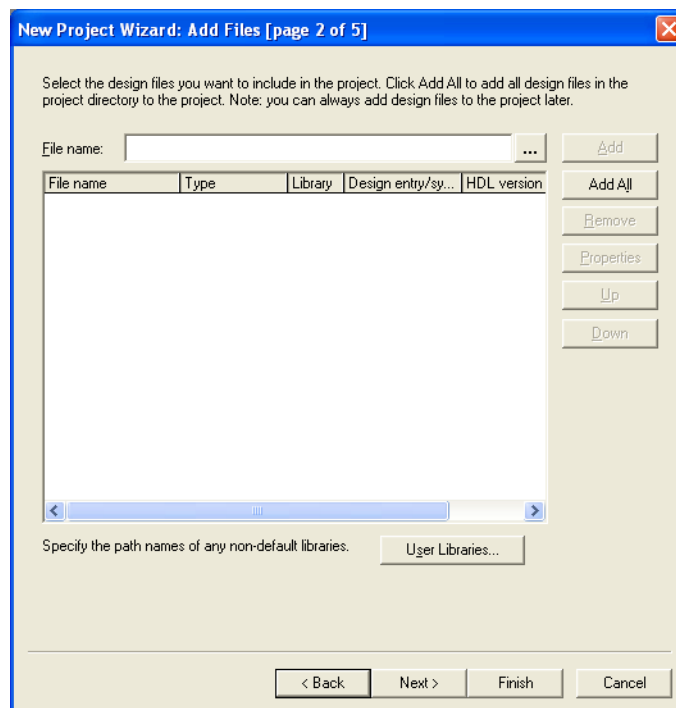

Figure 6. The wizard can include user-specified design files.

3. The wizard makes it easy to specify which existing files (if any) should be included in the project. Assuming that we do not have any existing files, click **Next**, which leads to the window in Figure 7.

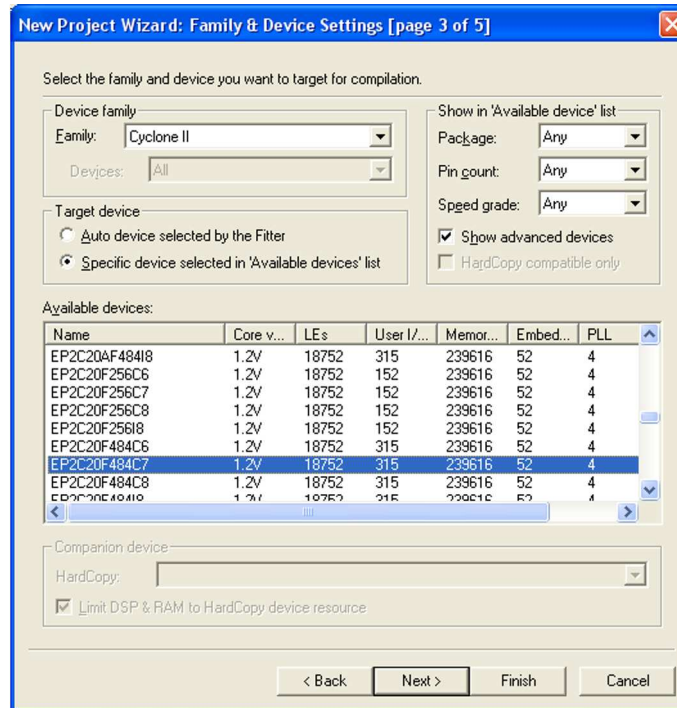

Figure 7. Choose the device family and a specific device.

4. We have to specify the type of device in which the designed circuit will be implemented. Choose Cyclone™ II as the target device family. We can let Quartus II software select a specific device in the family, or we can choose the device explicitly. We will take the latter approach. From the list of available devices, choose the device called EP2C20F484C7 which is the FPGA used on Altera's DE1 board. Press Next, which opens the window in Figure 8.

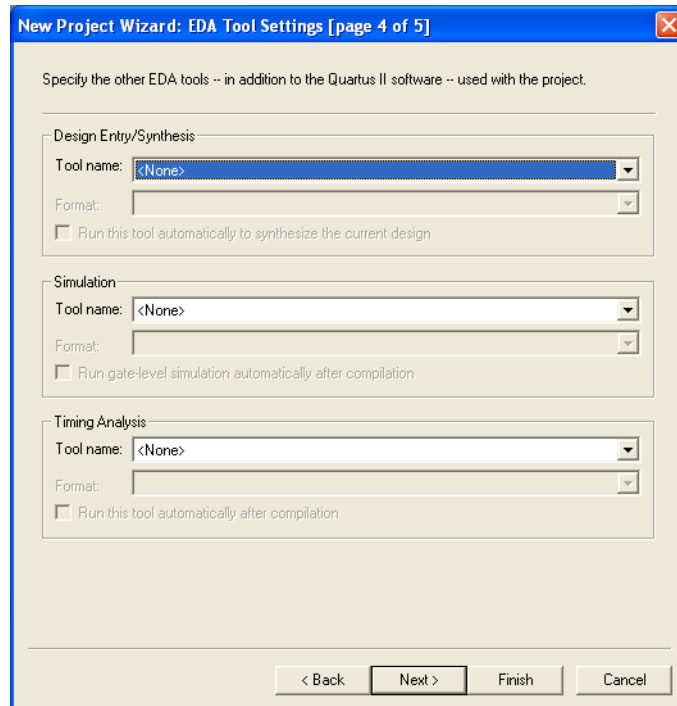

Figure 8. Other EDA tools can be specified.

5. The user can specify any third-party tools that should be used. A commonly used term for CAD software for electronic circuits is *EDA tools*, where the acronym stands for Electronic Design Automation. This term is used in Quartus II messages that refer to third-party tools, which are the tools developed and marketed by companies other than Altera. Since we will rely solely on Quartus II tools, we will not choose any other tools. Press **Next**.
6. A summary of the chosen settings appears in the screen shown in Figure 9. Press **Finish**, which returns to the main Quartus II window, but with *light* specified as the new project, in the display title bar, as indicated in Figure 10.

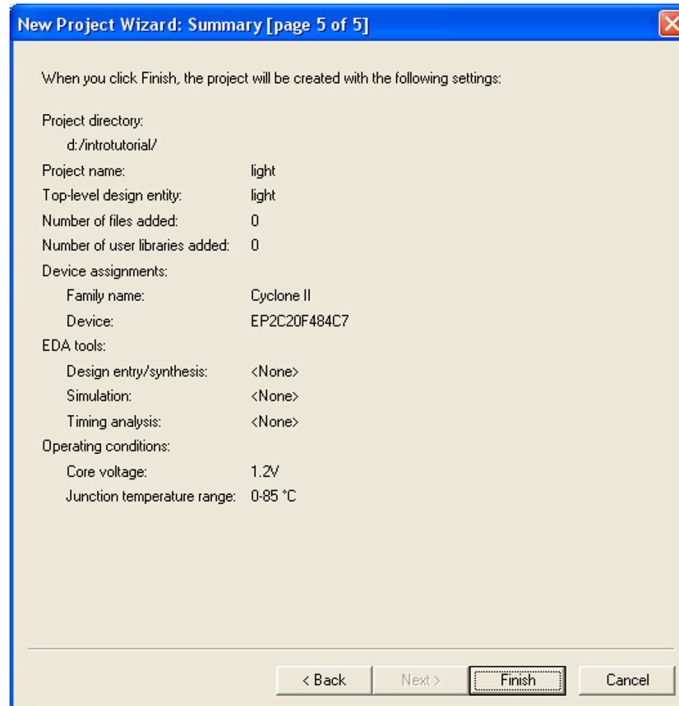

Figure 9. Summary of the project settings.

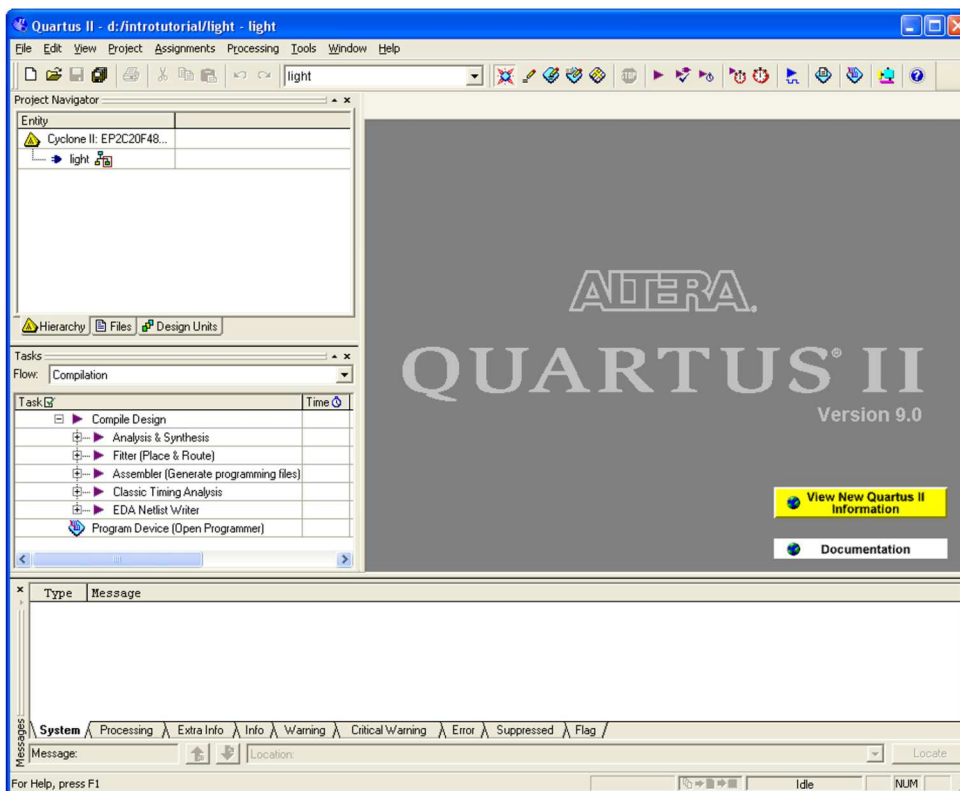

Figure 10. The Quartus II display for the created project.

3 Design Entry Using the Graphic Editor

As a design example, we will use the two-way light controller circuit shown in Figure 11. The circuit can be used to control a single light from either of the two switches, x_1 and x_2 , where a closed switch corresponds to the logic value 1. The truth table for the circuit is also given in the figure. Note that this is just the Exclusive-OR function of the inputs x_1 and x_2 , but we will implement it using the gates shown.

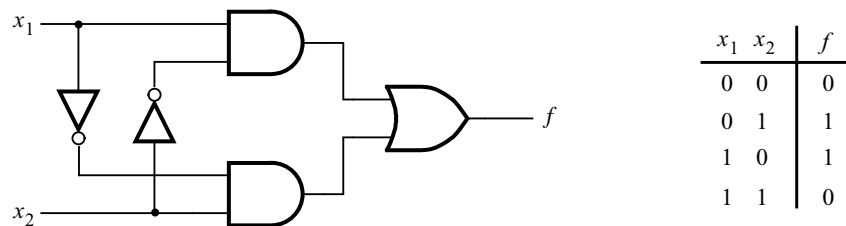

Figure 11. The light controller circuit.

The Quartus II Graphic Editor can be used to specify a circuit in the form of a block diagram. Select **File > New** to get the window in Figure 12, choose **Block Diagram/Schematic File**, and click **OK**. This opens the Graphic Editor window. The first step is to specify a name for the file that will be created. Select **File > Save As** to open the pop-up box depicted in Figure 13. In the box labeled **Save as type** choose **Block Diagram/Schematic File (*.bdf)**. In the box labeled **File name** type *light*, to match the name given in Figure 4, which was specified when the project was created. Put a checkmark in the box **Add file to current project**. Click **Save**, which puts the file into the directory *introtutorial* and leads to the Graphic Editor window displayed in Figure 14.

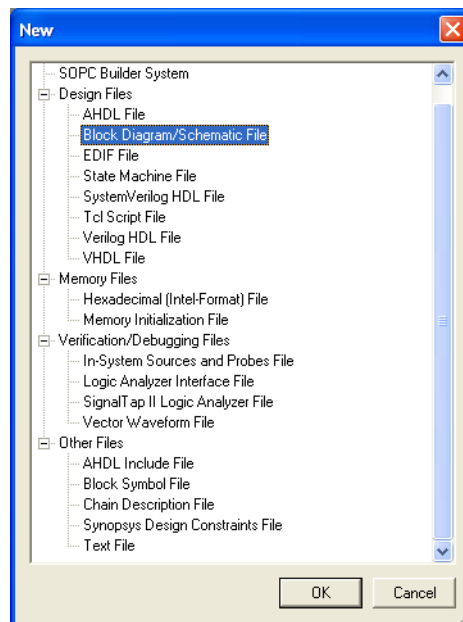

Figure 12. Choose to prepare a block diagram.

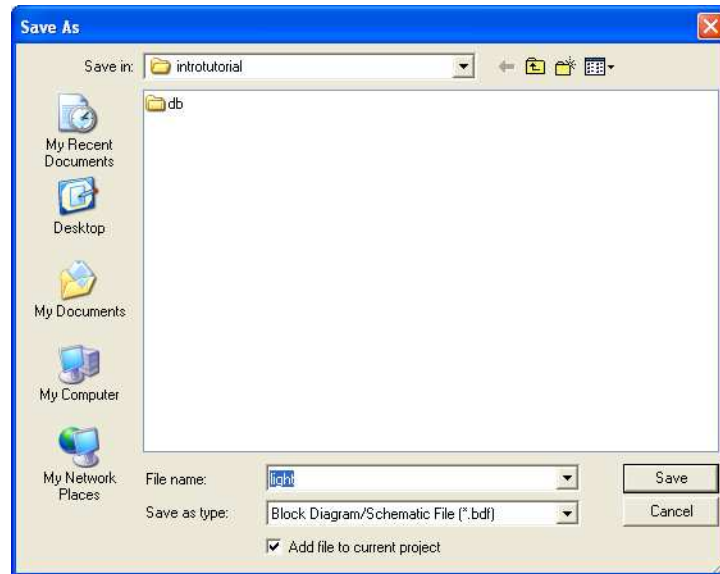

Figure 13. Name the file.

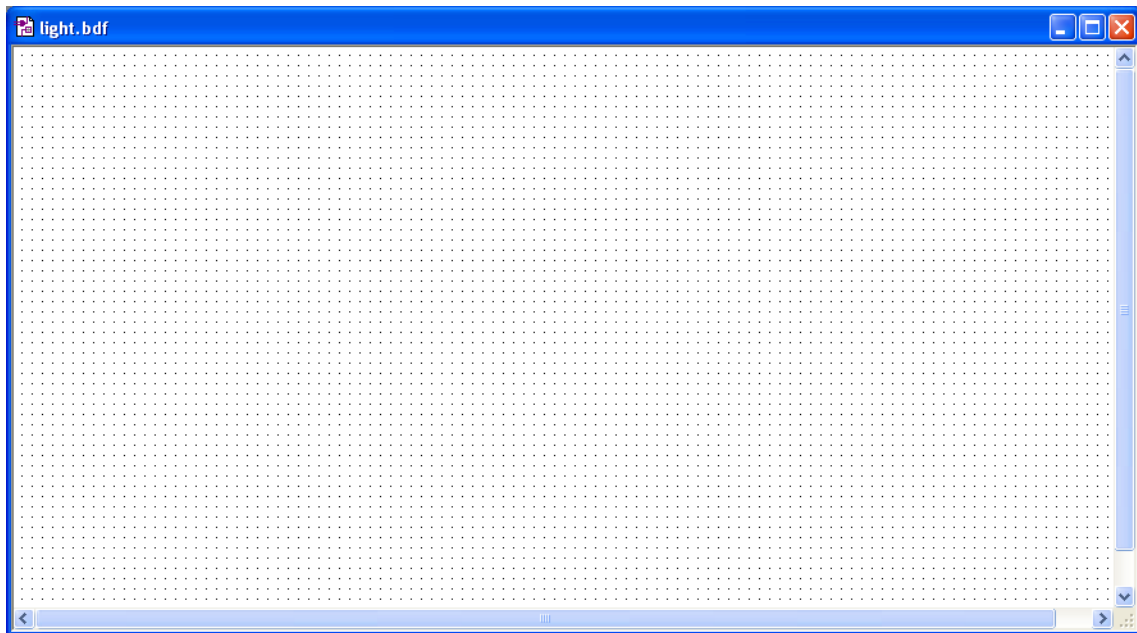



Figure 14. Graphic Editor window.

3.1 Importing Logic-Gate Symbols

The Graphic Editor provides a number of libraries which include circuit elements that can be imported into a schematic. Double-click on the blank space in the Graphic Editor window, or click on the  icon in the toolbar that looks like an AND gate. A pop-up box in Figure 15 will appear. Expand the hierarchy in the Libraries box as shown in the figure. First expand *libraries*, then expand the library *primitives*, followed by expanding the library *logic* which comprises the logic gates. Select *and2*, which is a two-input AND gate, and click OK. Now, the AND

gate symbol will appear in the Graphic Editor window. Using the mouse, move the symbol to a desirable location and click to place it there. Import the second AND gate, which can be done simply by positioning the mouse pointer over the existing AND-gate symbol, right-clicking, and dragging to make a copy of the symbol. A symbol in the Graphic Editor window can be moved by clicking on it and dragging it to a new location with the mouse button pressed. Next, select *or2* from the library and import the OR gate into the diagram. Then, select *not* and import two instances of the NOT gate. Rotate the NOT gates into proper position by using the “Rotate left 90°” icon . Arrange the gates as shown in Figure 16.

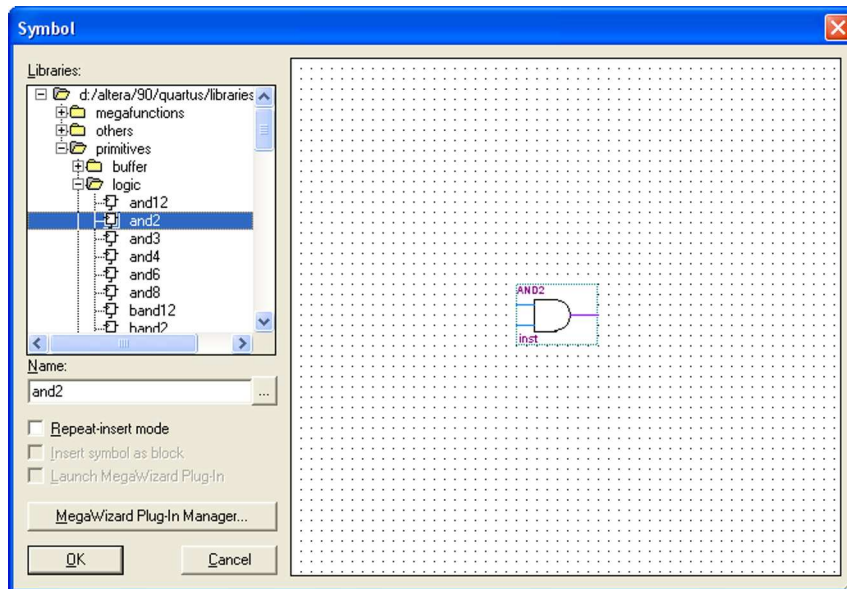

Figure 15. Choose a symbol from the library.

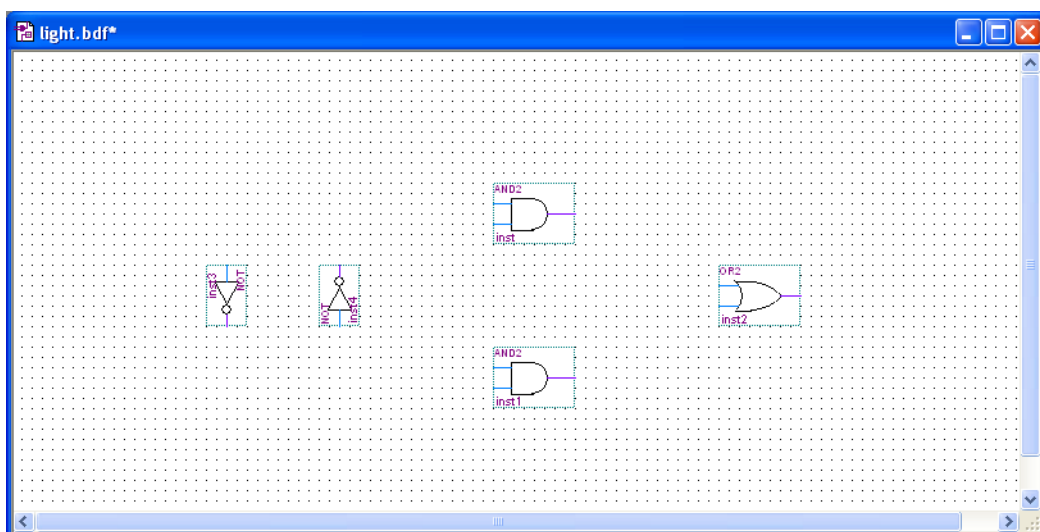

Figure 16. Import the gate symbols into the Graphic Editor window.

3.2 Importing Input and Output Symbols

Having entered the logic-gate symbols, it is now necessary to enter the symbols that represent the input and output ports of the circuit. Use the same procedure as for importing the gates, but choose the port symbols from the library *primitives/pin*. Import two instances of the input port and one instance of the output port, to obtain the image in Figure 17.

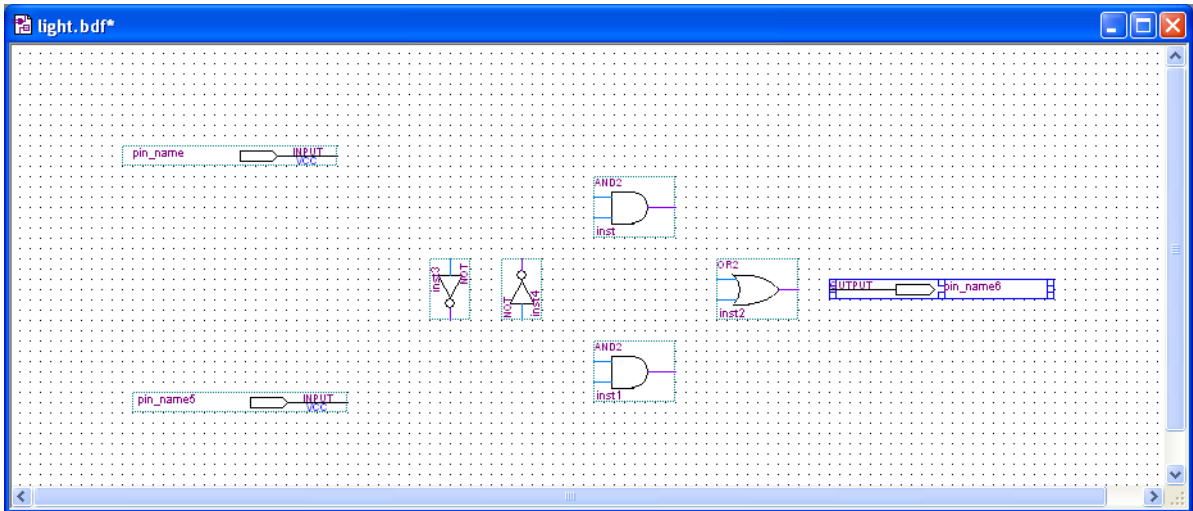

Figure 17. Import the input and output pins.

Assign names to the input and output symbols as follows. Make sure nothing is selected by clicking on an empty spot in the Graphic Editor window. Point to the word *pin_name* on the top input symbol and double-click the mouse. The dialog box in Figure 18 will appear. Type the pin name, *x1*, and click OK. Similarly, assign the name *x2* to the other input and *f* to the output. Alternatively, it is possible to change the name of an element by selecting it first, and then double-clicking on the name and typing a new one directly.

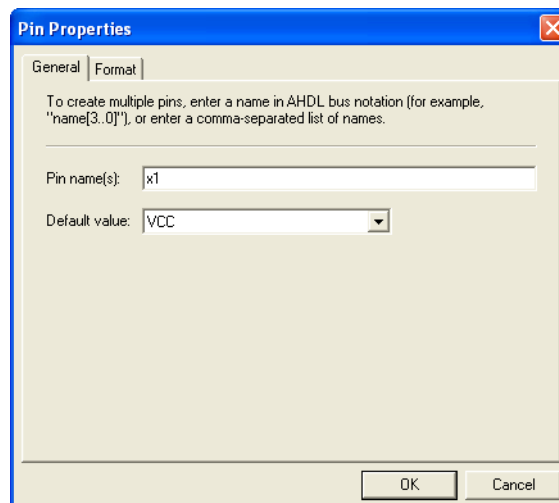



Figure 18. Naming of a pin.

3.3 Connecting Nodes with Wires

The symbols in the diagram have to be connected by drawing lines (wires). Click on the icon  in the toolbar to activate the Orthogonal Node Tool. Position the mouse pointer over the right edge of the $x1$ input pin. Click and hold the mouse button and drag the mouse to the right until the drawn line reaches the pinstub on the top input of the AND gate. Release the mouse button, which leaves the line connecting the two pinstubs. Next, draw a wire from the input pinstub of the leftmost NOT gate to touch the wire that was drawn above it. Note that a dot will appear indicating a connection between the two wires.

Use the same procedure to draw the remaining wires in the circuit. If a mistake is made, a wire can be selected by clicking on it, and removed by pressing the Delete key on the keyboard. Upon completing the diagram, click on the icon , to activate the Selection Tool. Now, changes in the appearance of the diagram can be made by selecting a particular symbol or wire and either moving it to a different location or deleting it. The final diagram is shown in Figure 19; save it.

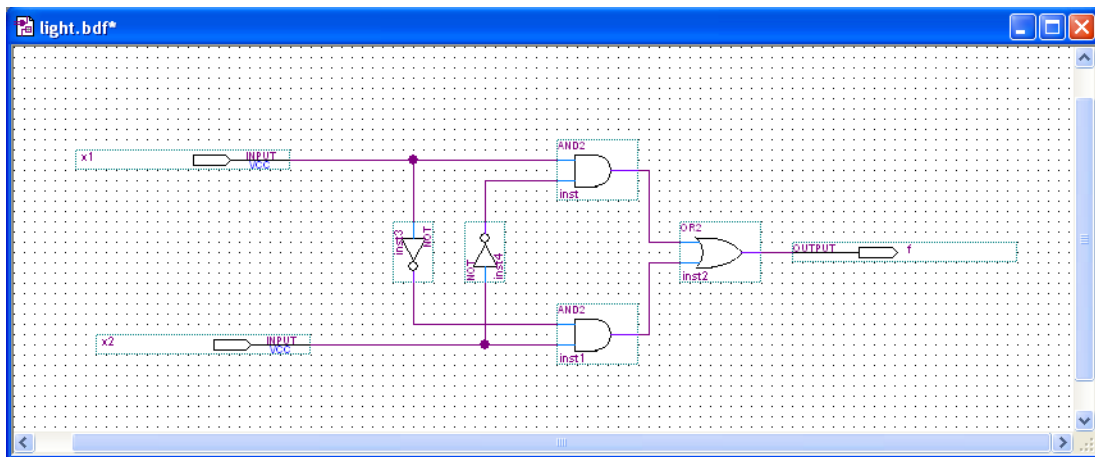



Figure 19. The completed schematic diagram.

4 Compiling the Designed Circuit

The entered schematic diagram file, *light.bdf*, is processed by several Quartus II tools that analyze the file, synthesize the circuit, and generate an implementation of it for the target chip. These tools are controlled by the application program called the *Compiler*.

Run the Compiler by selecting Processing > Start Compilation, or by clicking on the toolbar icon  that looks like a purple triangle. As the compilation moves through various stages, its progress is reported in a window on the left side of the Quartus II display. Successful (or unsuccessful) compilation is indicated in a pop-up box. Acknowledge it by clicking OK, which leads to the Quartus II display in Figure 20. In the message window, at the bottom of the figure, various messages are displayed. In case of errors, there will be appropriate messages given.

When the compilation is finished, a compilation report is produced. A window showing this report is opened automatically, as seen in Figure 20. The window can be resized, maximized, or closed in the normal way, and it can be opened at any time either by selecting Processing > Compilation Report or by clicking on the icon . The report includes a number of sections listed on the left side of its window. Figure 20 displays the Compiler Flow Summary section, which indicates that only one logic element and three pins are needed to implement this tiny circuit on the selected FPGA chip.

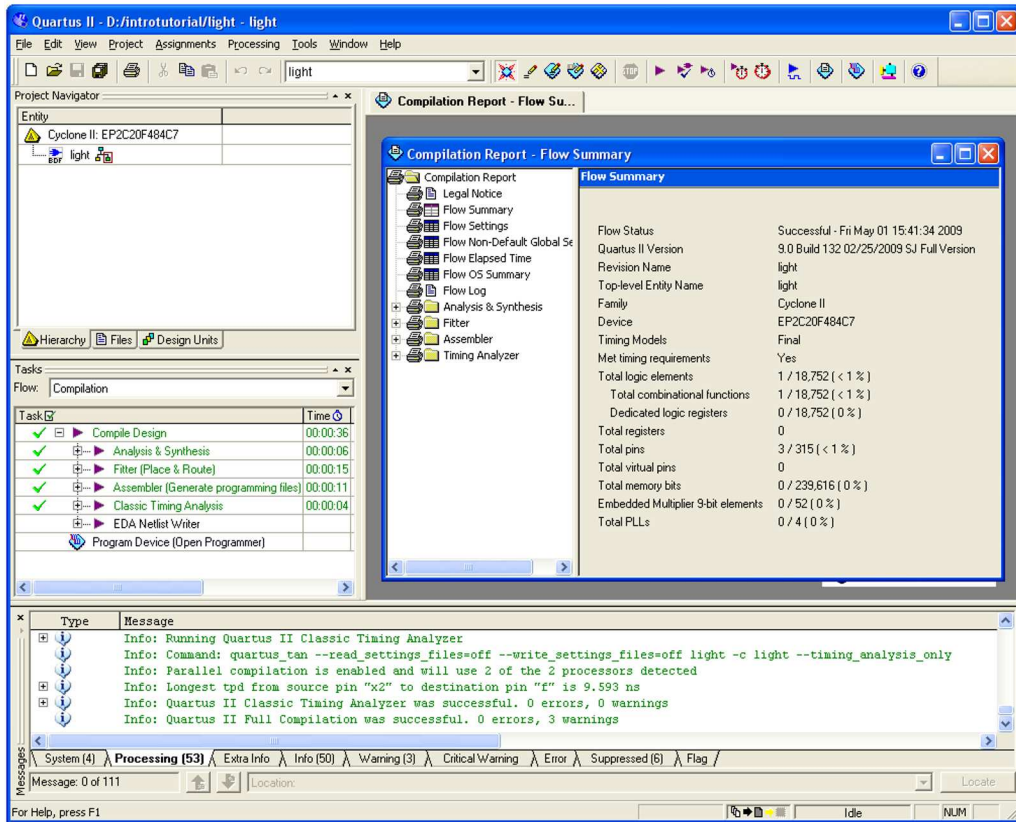



Figure 20. Display after a successful compilation.

4.1 Errors

Quartus II software displays messages produced during compilation in the Messages window. If the block diagram design file is correct, one of the messages will state that the compilation was successful and that there are no errors.

If the Compiler does not report zero errors, then there is at least one mistake in the schematic entry. In this case a message corresponding to each error found will be displayed in the Messages window. Double-clicking on an error message will highlight the offending part of the circuit in the Graphic Editor window. Similarly, the Compiler may display some warning messages. Their details can be explored in the same way as in the case of error messages. The user can obtain more information about a specific error or warning message by selecting the message and pressing the F1 function key.

To see the effect of an error, open the file *light.bdf*. Remove the wire connecting the output of the top AND gate to the OR gate. To do this, click on the  icon, click the mouse on the wire to be removed (to select it) and press Delete. Compile the erroneous design by clicking on the  icon. A pop-up box will ask if the changes made to the *light.bdf* file should be saved; click Yes. After trying to compile the circuit, Quartus II software will display a pop-up box indicating that the compilation was not successful. Acknowledge it by clicking OK. The compilation report summary, given in Figure 21, now confirms the failed result. Expand the Analysis & Synthesis part of the report and then select Messages to have the messages displayed as shown in Figure 22. Double-click on the first error message, which states that one of the nodes is missing a source. Quartus II software responds by displaying the *light.bdf* schematic and highlighting the OR gate which is affected by the error, as shown in Figure 23. Correct the error and recompile the design.

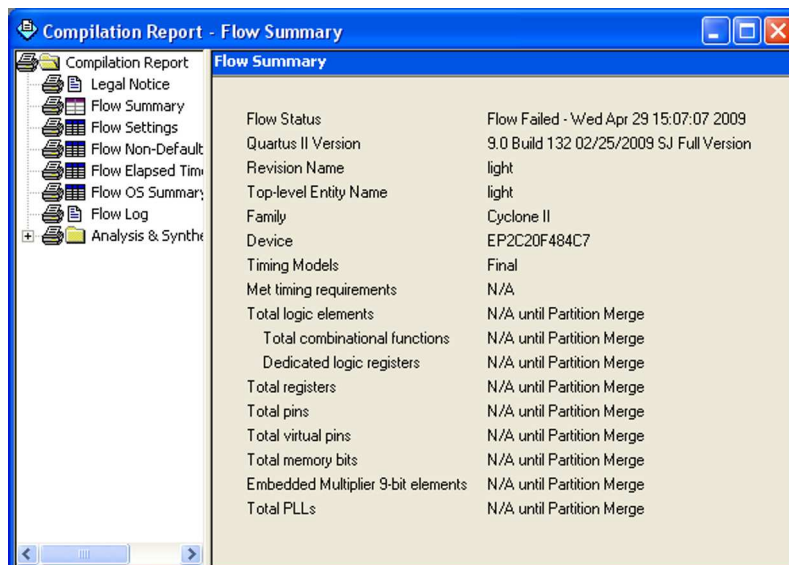

Flow Summary	
Flow Status	Flow Failed - Wed Apr 29 15:07:07 2009
Quartus II Version	9.0 Build 132 02/25/2009 SJ Full Version
Revision Name	light
Top-level Entity Name	light
Family	Cyclone II
Device	EP2C20F484C7
Timing Models	Final
Met timing requirements	N/A
Total logic elements	N/A until Partition Merge
Total combinational functions	N/A until Partition Merge
Dedicated logic registers	N/A until Partition Merge
Total registers	N/A until Partition Merge
Total pins	N/A until Partition Merge
Total virtual pins	N/A until Partition Merge
Total memory bits	N/A until Partition Merge
Embedded Multiplier 9-bit elements	N/A until Partition Merge
Total PLLs	N/A until Partition Merge

Figure 21. Compilation report for the failed design.

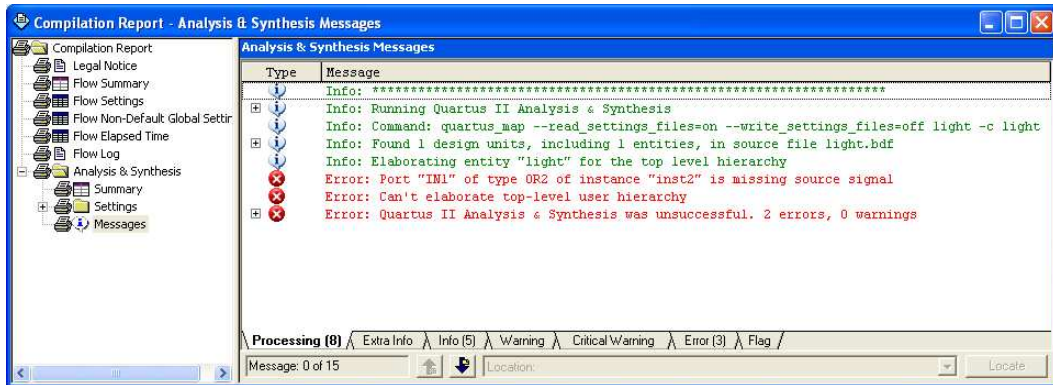

Figure 22. Error messages.

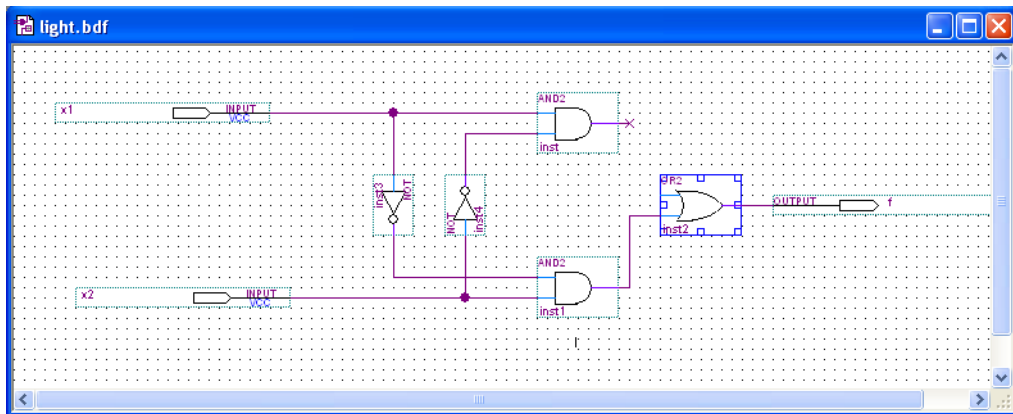

Figure 23. Identifying the location of the error.

5 Pin Assignment

During the compilation above, the Quartus II Compiler was free to choose any pins on the selected FPGA to serve as inputs and outputs. However, the DE1 board has hardwired connections between the FPGA pins and the other components on the board. We will use two toggle switches, labeled SW_0 and SW_1 , to provide the external inputs, x_1 and x_2 , to our example circuit. These switches are connected to the FPGA pins L22 and L21, respectively. We will connect the output f to the green light-emitting diode labeled $LEDG_0$, which is hardwired to the FPGA pin U22.

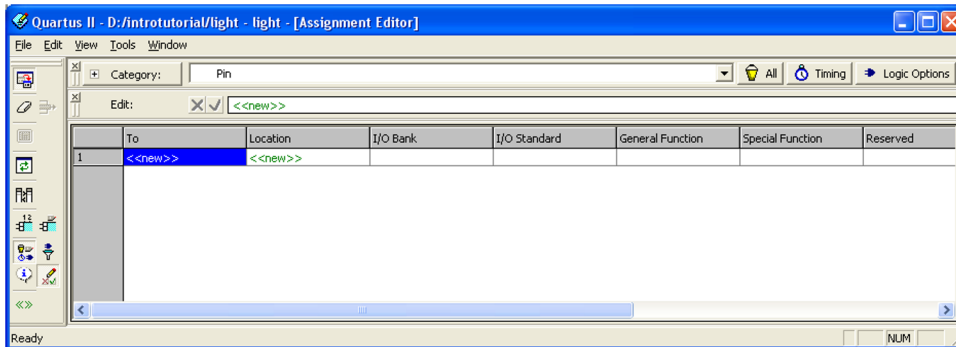

Figure 24. The Assignment Editor window.

Pin assignments are made by using the Assignment Editor. Select **Assignments > Assignment Editor** to reach the window in Figure 24. Under **Category** select **Pin**. Double-click on the entry **<<new>>** which is highlighted in blue in the column labeled **To**. The drop-down menu in Figure 25 will appear. Click on *x1* as the first pin to be assigned; this will enter *x1* in the displayed table. Follow this by double-clicking on the box to the right of this new *x1* entry, in the column labeled **Location**. Now, the drop-down menu in Figure 26 appears. Scroll down and select **PIN_L22**. Instead of scrolling down the menu to find the desired pin, you can just type the name of the pin (L22) in the **Location** box. Use the same procedure to assign input *x2* to pin L21 and output *f* to pin U22, which results in the image in Figure 27. To save the assignments made, choose **File > Save**. You can also simply close the Assignment Editor window, in which case a pop-up box will ask if you want to save the changes to assignments; click **Yes**. Recompile the circuit, so that it will be compiled with the correct pin assignments.

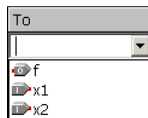

Figure 25. The drop-down menu displays the input and output names.

Location	I/O Bank	I/O Standard	General Function	Special Fur
		3.3-V LVTTL		
PIN_L15	I/O Bank 5	Row I/O		
PIN_L17	I/O Bank 5	Row I/O	LVDS72n	
PIN_L18	I/O Bank 5	Row I/O	LVDS73p	
PIN_L19	I/O Bank 5	Row I/O	LVDS73n	
PIN_L20	I/O Bank 5	Row I/O	LVDS74n	
PIN_L21	I/O Bank 5	Row I/O	LVDS75n	
PIN_L22	I/O Bank 5	Row I/O	LVDS75p	
PIN_K20	I/O Bank 5	Row I/O	VREFB5N1	
PIN_K21	I/O Bank 5	Row I/O	LVDS76n	
PIN_K22	I/O Bank 5	Row I/O	LVDS76p	
PIN_L11	I/O Bank 2	Dedicated Clock	CLK0, LVDSCLK0p, Input	
PIN_L12	I/O Bank 2	Dedicated Clock	CLK1, LVDSCLK0n, Input	
PIN_L8	I/O Bank 2	Row I/O		
PIN_L18	I/O Bank 5	Row I/O	LVDS77p, DPCLK7/DQS0R/CQ1R	
PIN_L19	I/O Bank 5	Row I/O	LVDS77n	
PIN_L21	I/O Bank 5	Dedicated Clock	CLK5, LVDSCLK2n, Input	
PIN_L22	I/O Bank 5	Dedicated Clock	CLK4, LVDSCLK2p, Input	
PIN_M1	I/O Bank 1	Dedicated Clock	CLK2, LVDSCLK1p, Input	
PIN_M2	I/O Bank 1	Dedicated Clock	CLK3, LVDSCLK1n, Input	
PIN_M5	I/O Bank 1	Row I/O	LVDS15p, DPCLK1/DQS1L/CQ1L#	

Figure 26. The available pins.

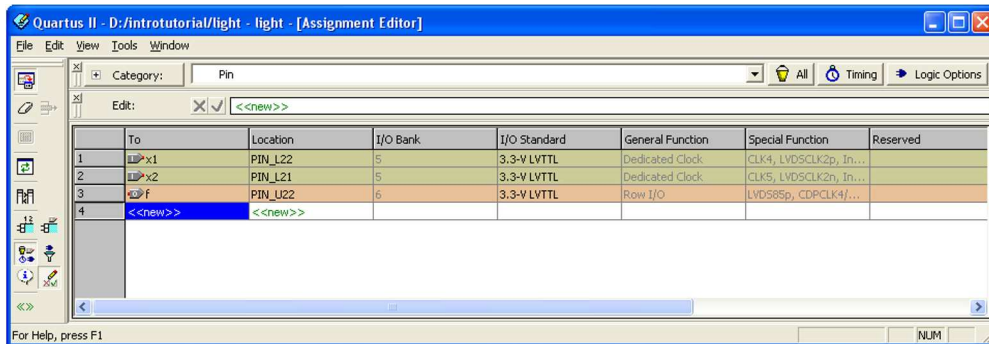

Figure 27. The complete assignment.

The DE1 board has fixed pin assignments. Having finished one design, the user will want to use the same pin assignment for subsequent designs. Going through the procedure described above becomes tedious if there are many pins used in the design. A useful Quartus II feature allows the user to both export and import the pin assignments from a special file format, rather than creating them manually using the Assignment Editor. A simple file format that can be used for this purpose is the *comma separated value (CSV)* format, which is a common text file format that contains comma-delimited values. This file format is often used in conjunction with the Microsoft Excel spreadsheet program, but the file can also be created by hand using any plain ASCII text editor. The format for the file for our simple project is

```
To, Location
x1, PIN_L22
x2, PIN_L21
f, PIN_U22
```

By adding lines to the file, any number of pin assignments can be created. Such *csv* files can be imported into any design project.

If you created a pin assignment for a particular project, you can export it for use in a different project. To see how this is done, open again the Assignment Editor to reach the window in Figure 27. Now, select **File > Export** which leads to the window in Figure 28. Here, the file *light.csv* is available for export. Click on **Export**. If you now look in the directory *introtutorial*, you will see that the file *light.csv* has been created.

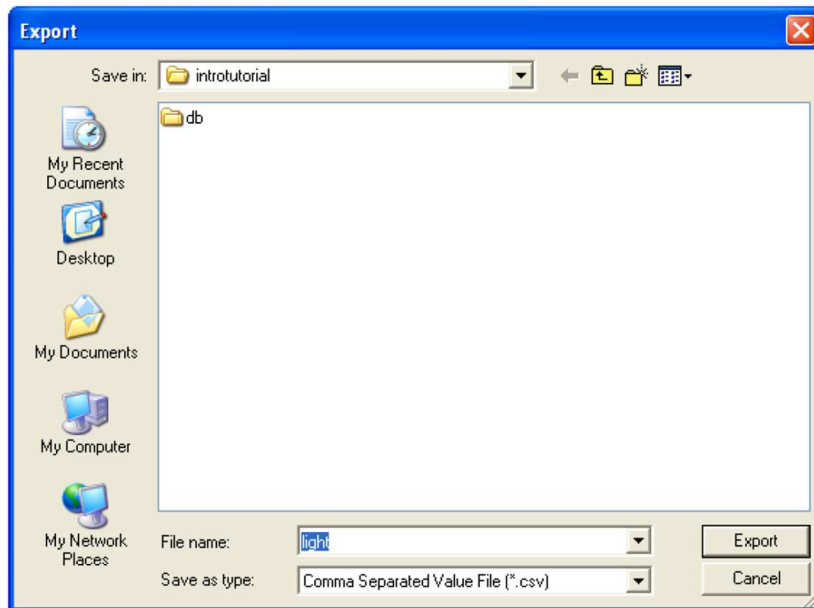

Figure 28. Exporting the pin assignment.

You can import a pin assignment by choosing **Assignments > Import Assignments**. This opens the dialogue in Figure 29 to select the file to import. Type the name of the file, including the *csv* extension and the full path to the directory that holds the file, in the File Name box and press OK. Of course, you can also browse to find the desired file.

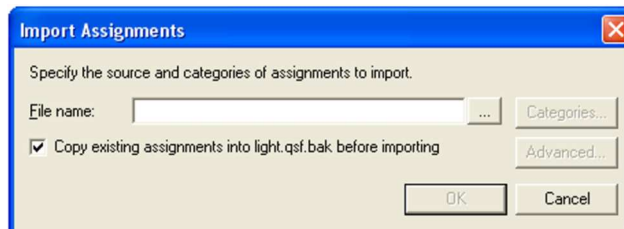

Figure 29. Importing the pin assignment.

For convenience when using large designs, all relevant pin assignments for the DE1 board are given in the file called *DE1_pin_assignments.csv* in the directory *DE1_tutorials\design_files*, which is included on the CD-ROM that accompanies the DE1 board and can also be found on Altera's DE1 web pages. This file uses the names found in the *DE1 User Manual*. If we wanted to make the pin assignments for our example circuit by importing this file, then we would have to use the same names in our Block Diagram/Schematic design file; namely, *SW[0]*, *SW[1]* and *LEDG[0]* for *x1*, *x2* and *f*, respectively. Since these signals are specified in the *DE1_pin_assignments.csv* file as elements of vectors *SW* and *LEDG*, we must refer to them in the same way in our design file. For example, in the *DE1_pin_assignments.csv* file the 10 toggle switches are called *SW[9]* to *SW[0]*. In a design file they can also be referred to as a vector *SW[9..0]*.

6 Simulating the Designed Circuit

Before implementing the designed circuit in the FPGA chip on the DE1 board, it is prudent to simulate it to ascertain its correctness. Quartus II software includes a simulation tool that can be used to simulate the behavior

of a designed circuit. Before the circuit can be simulated, it is necessary to create the desired waveforms, called *test vectors*, to represent the input signals. It is also necessary to specify which outputs, as well as possible internal points in the circuit, the designer wishes to observe. The simulator applies the test vectors to a model of the implemented circuit and determines the expected response. We will use the Quartus II Waveform Editor to draw the test vectors, as follows:

1. Open the Waveform Editor window by selecting File > New, which gives the window shown in Figure 30. Choose Vector Waveform File and click OK.

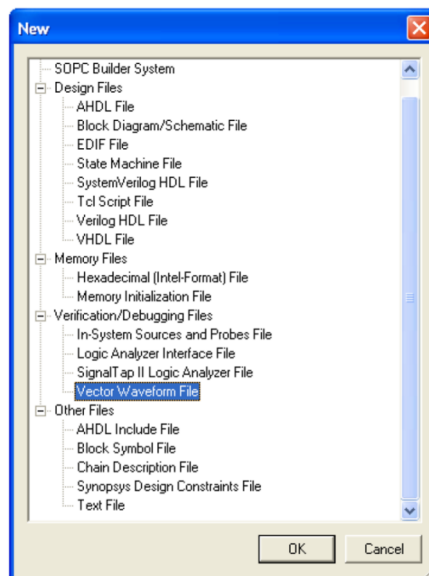

Figure 30. Need to prepare a new file.

2. The Waveform Editor window is depicted in Figure 31. Save the file under the name *light.vwf*; note that this changes the name in the displayed window. Set the desired simulation to run from 0 to 200 ns by selecting Edit > End Time and entering 200 ns in the dialog box that pops up. Selecting View > Fit in Window displays the entire simulation range of 0 to 200 ns in the window, as shown in Figure 32. You may wish to resize the window to its maximum size.

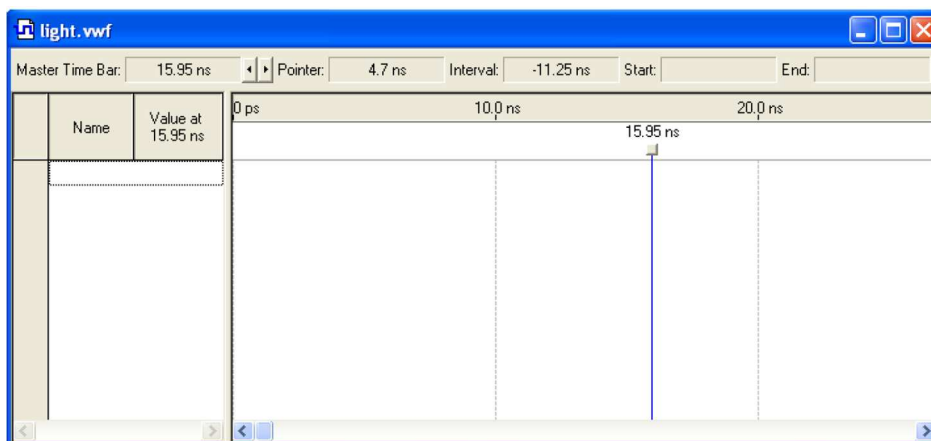

Figure 31. The Waveform Editor window.

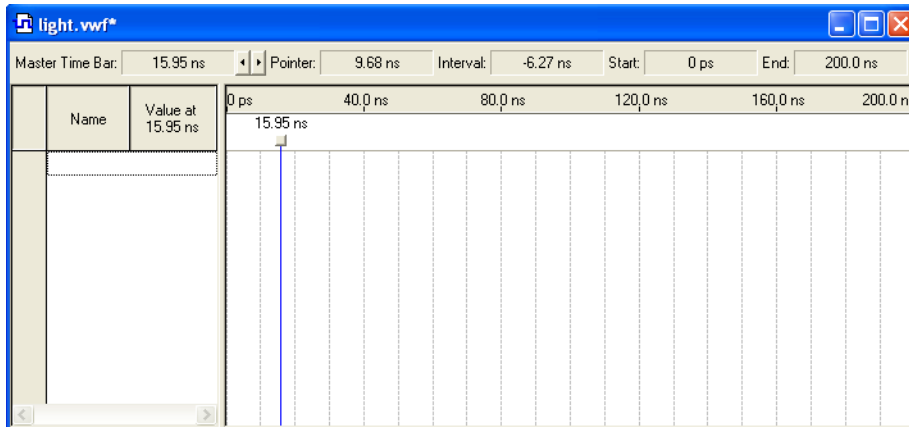

Figure 32. The augmented Waveform Editor window.

- Next, we want to include the input and output nodes of the circuit to be simulated. Click **Edit > Insert > Insert Node or Bus** to open the window in Figure 33. It is possible to type the name of a signal (pin) into the Name box, but it is easier to click on the button labeled **Node Finder** to open the window in Figure 34. The Node Finder utility has a filter used to indicate what type of nodes are to be found. Since we are interested in input and output pins, set the filter to **Pins: all**. Click the **List** button to find the input and output nodes as indicated on the left side of the figure.

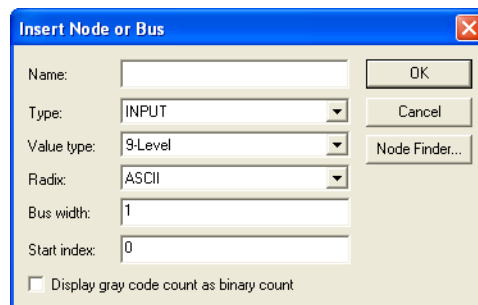

Figure 33. The Insert Node or Bus dialogue.

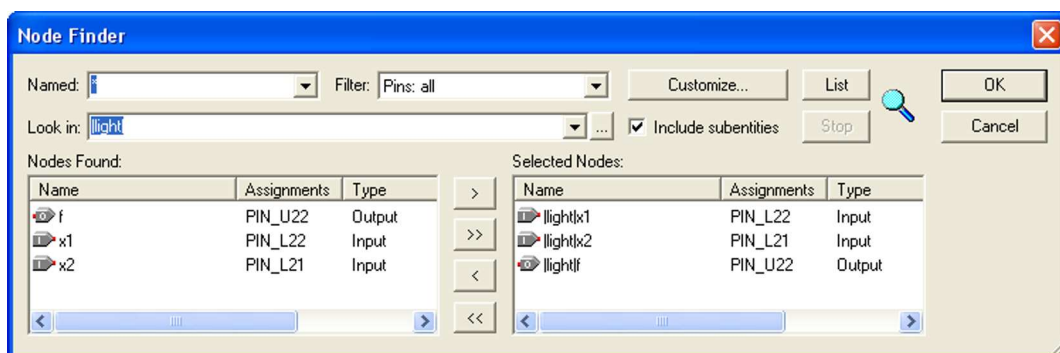

Figure 34. Selecting nodes to insert into the Waveform Editor.

Click on the $x1$ signal in the Nodes Found box in Figure 34, and then click the $>$ sign to add it to the Selected Nodes box on the right side of the figure. Do the same for $x2$ and f . Click OK to close the Node Finder window, and then click OK in the window of Figure 33. This leaves a fully displayed Waveform Editor window, as shown in Figure 35. If you did not select the nodes in the same order as displayed in Figure 35, it is possible to rearrange them. To move a waveform up or down in the Waveform Editor window, click on the node name (in the Name column) and release the mouse button. The waveform is now highlighted to show the selection. Click again on the waveform and drag it up or down in the Waveform Editor.

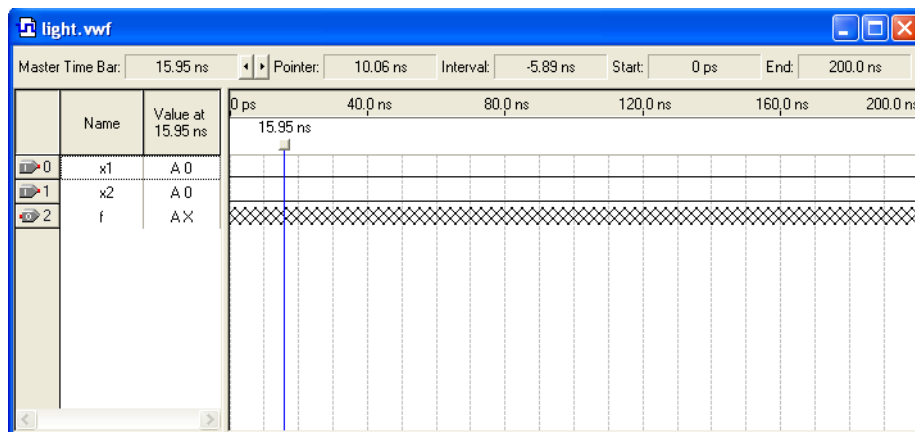



Figure 35. The nodes needed for simulation.

- We will now specify the logic values to be used for the input signals $x1$ and $x2$ during simulation. The logic values at the output f will be generated automatically by the simulator. To make it easy to draw the desired waveforms, the Waveform Editor displays (by default) vertical guidelines and provides a drawing feature that snaps on these lines (which can otherwise be invoked by choosing View $>$ Snap to Grid). Observe also a solid vertical line, which can be moved by pointing to its top and dragging it horizontally. This reference line is used in analyzing the timing of a circuit; move it to the $time = 0$ position. The waveforms can be drawn using the Selection Tool, which is activated by selecting the icon  in the toolbar, or the Waveform Editing Tool, which is activated by the icon .

To simulate the behavior of a large circuit, it is necessary to apply a sufficient number of input valuations and observe the expected values of the outputs. In a large circuit the number of possible input valuations may be huge, so in practice we choose a relatively small (but representative) sample of these input valuations. However, for our tiny circuit we can simulate all four input valuations given in Figure 11. We will use four 50-ns time intervals to apply the four test vectors.

We can generate the desired input waveforms as follows. Click on the waveform name for the $x1$ node. Once a waveform is selected, the editing commands in the Waveform Editor can be used to draw the desired waveforms. Commands are available for setting a selected signal to 0, 1, unknown (X), high impedance (Z), don't care (DC), inverting its existing value (INV), or defining a clock waveform. Each command can be activated by using the Edit $>$ Value command, or via the toolbar for the Waveform Editor. The Edit menu can also be opened by right-clicking on a waveform name.

Set $x1$ to 0 in the time interval 0 to 100 ns, which is probably already set by default. Next, set $x1$ to 1 in the time interval 100 to 200 ns. Do this by pressing the mouse at the start of the interval and dragging it to its end, which highlights the selected interval, and choosing the logic value 1 in the toolbar. Make $x2 = 1$ from 50 to 100 ns and also from 150 to 200 ns, which corresponds to the truth table in Figure 11. This should

produce the image in Figure 36. Observe that the output f is displayed as having an unknown value at this time, which is indicated by a hashed pattern; its value will be determined during simulation. Save the file.

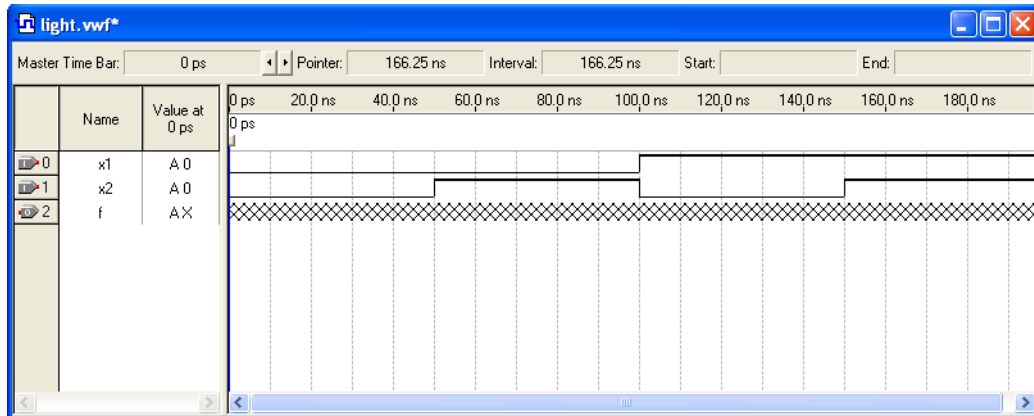



Figure 36. Setting of test values.

6.1 Performing the Simulation

A designed circuit can be simulated in two ways. The simplest way is to assume that logic elements and interconnection wires in the FPGA are perfect, thus causing no delay in propagation of signals through the circuit. This is called *functional simulation*. A more complex alternative is to take all propagation delays into account, which leads to *timing simulation*. Typically, functional simulation is used to verify the functional correctness of a circuit as it is being designed. This takes much less time, because the simulation can be performed simply by using the logic expressions that define the circuit.

6.1.1 Functional Simulation

To perform the functional simulation, select **Assignments > Settings** to open the Settings window. On the left side of this window click on **Simulator Settings** to display the window in Figure 37, choose **Functional** as the simulation mode, and click **OK**. The Quartus II simulator takes the inputs and generates the outputs defined in the *light.vwf* file. Before running the functional simulation it is necessary to create the required netlist, which is done by selecting **Processing > Generate Functional Simulation Netlist**. A simulation run is started by **Processing > Start Simulation**, or by using the icon . At the end of the simulation, Quartus II software indicates its successful completion and displays a Simulation Report illustrated in Figure 38. If your report window does not show the entire simulation time range, click on the report window to select it and choose **View > Fit in Window**. Observe that the output f is as specified in the truth table of Figure 11.

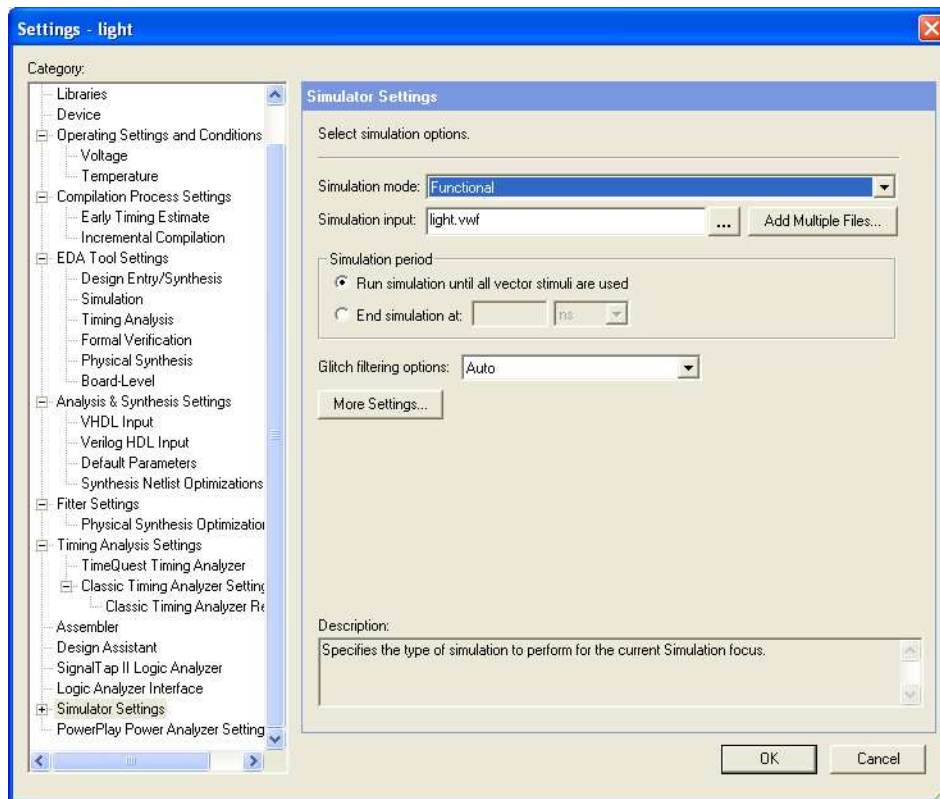

Figure 37. Specifying the simulation mode.

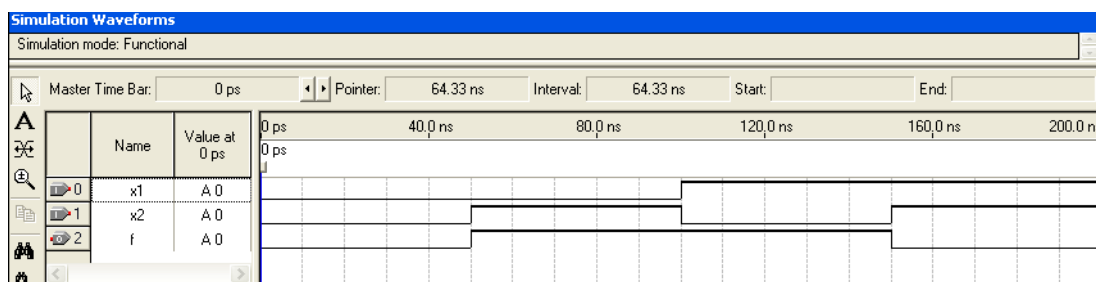

Figure 38. The result of functional simulation.

6.1.2 Timing Simulation

Having ascertained that the designed circuit is functionally correct, we should now perform the timing simulation to see how it will behave when it is actually implemented in the chosen FPGA device. Select **Assignments > Settings > Simulator Settings** to get to the window in Figure 37, choose **Timing** as the simulation mode, and click **OK**. Run the simulator, which should produce the waveforms in Figure 39. Observe that there is a delay of about 9 ns in producing a change in the signal f from the time when the input signals, x_1 and x_2 , change their values. This delay is due to the propagation delays in the logic element and the wires in the FPGA device.

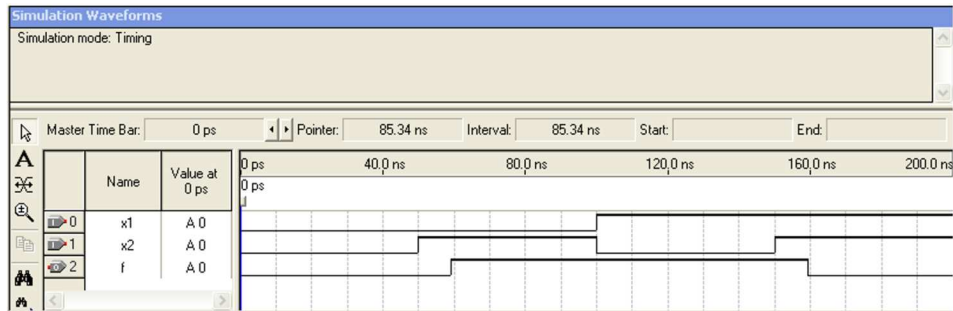

Figure 39. The result of timing simulation.

7 Programming and Configuring the FPGA Device

The FPGA device must be programmed and configured to implement the designed circuit. The required configuration file is generated by the Quartus II Compiler's Assembler module. Altera's DE1 board allows the configuration to be done in two different ways, known as JTAG and AS modes. The configuration data is transferred from the host computer (which runs the Quartus II software) to the board by means of a cable that connects a USB port on the host computer to the leftmost USB connector on the board. To use this connection, it is necessary to have the USB-Blaster driver installed. If this driver is not already installed, consult the tutorial *Getting Started with Altera's DE1 Board* for information about installing the driver. Before using the board, make sure that the USB cable is properly connected and turn on the power supply switch on the board.

In the JTAG mode, the configuration data is loaded directly into the FPGA device. The acronym JTAG stands for Joint Test Action Group. This group defined a simple way for testing digital circuits and loading data into them, which became an IEEE standard. If the FPGA is configured in this manner, it will retain its configuration as long as the power remains turned on. The configuration information is lost when the power is turned off. The second possibility is to use the Active Serial (AS) mode. In this case, a configuration device that includes some flash memory is used to store the configuration data. Quartus II software places the configuration data into the configuration device on the DE1 board. Then, this data is loaded into the FPGA upon power-up or reconfiguration. Thus, the FPGA need not be configured by the Quartus II software if the power is turned off and on. The choice between the two modes is made by the RUN/PROG switch on the DE1 board. The RUN position selects the JTAG mode, while the PROG position selects the AS mode.

7.1 JTAG Programming

The programming and configuration task is performed as follows. Flip the RUN/PROG switch into the RUN position. Select Tools > Programmer to reach the window in Figure 40. Here it is necessary to specify the programming hardware and the mode that should be used. If not already chosen by default, select JTAG in the Mode box. Also, if the USB-Blaster is not chosen by default, press the Hardware Setup... button and select the USB-Blaster in the window that pops up, as shown in Figure 41.

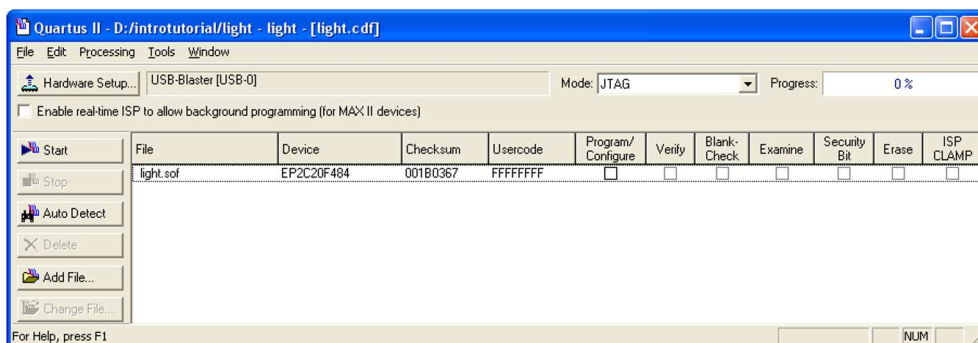

Figure 40. The Programmer window.

Observe that the configuration file *light.sof* is listed in the window in Figure 40. If the file is not already listed, then click Add File and select it. This is a binary file produced by the Compiler's Assembler module, which contains the data needed to configure the FPGA device. The extension *.sof* stands for SRAM Object File. Note also that the device selected is EP2C20F484, which is the FPGA device used on the DE1 board. Click on the Program/Configure check box, as shown in Figure 42.

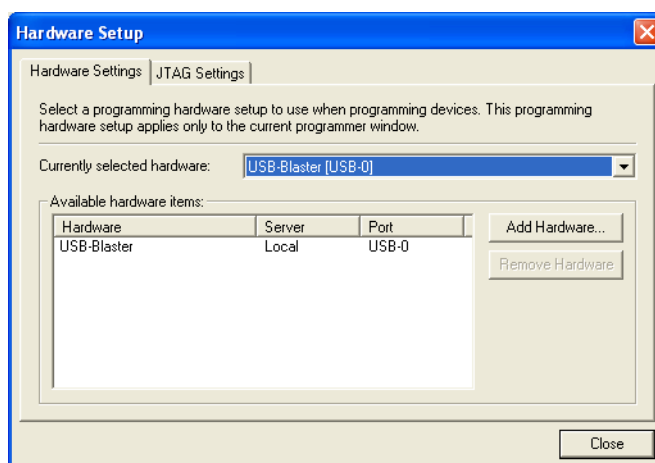

Figure 41. The Hardware Setup window.

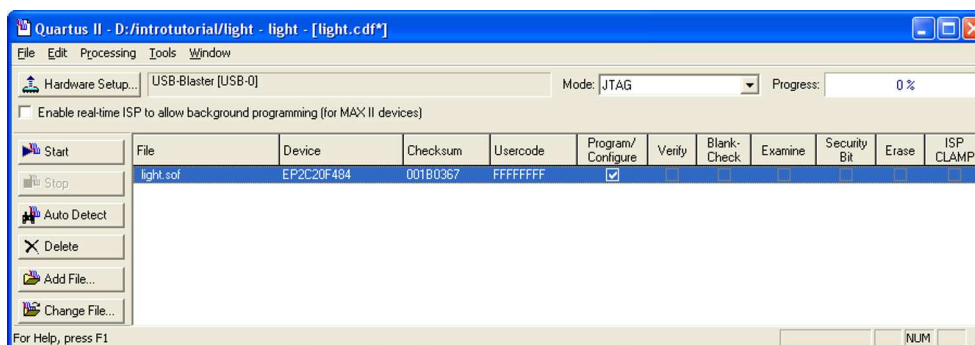

Figure 42. The updated Programmer window.

Now, press Start in the window in Figure 42. An LED on the board will light up when the configuration data has been downloaded successfully. If you see an error reported by Quartus II software indicating that programming failed, then check to ensure that the board is properly powered on.

7.2 Active Serial Mode Programming

In this case, the configuration data has to be loaded into the configuration device on the DE1 board, which is identified by the name EPCS4. To specify the required configuration device select **Assignments > Device**, which leads to the window in Figure 43. Click on the **Device and Pin Options** button to reach the window in Figure 44. Now, click on the **Configuration** tab to obtain the window in Figure 45. In the Configuration device box (which may be set to Auto) choose EPCS4 and click OK. Upon returning to the window in Figure 43, click OK. Recompile the designed circuit.

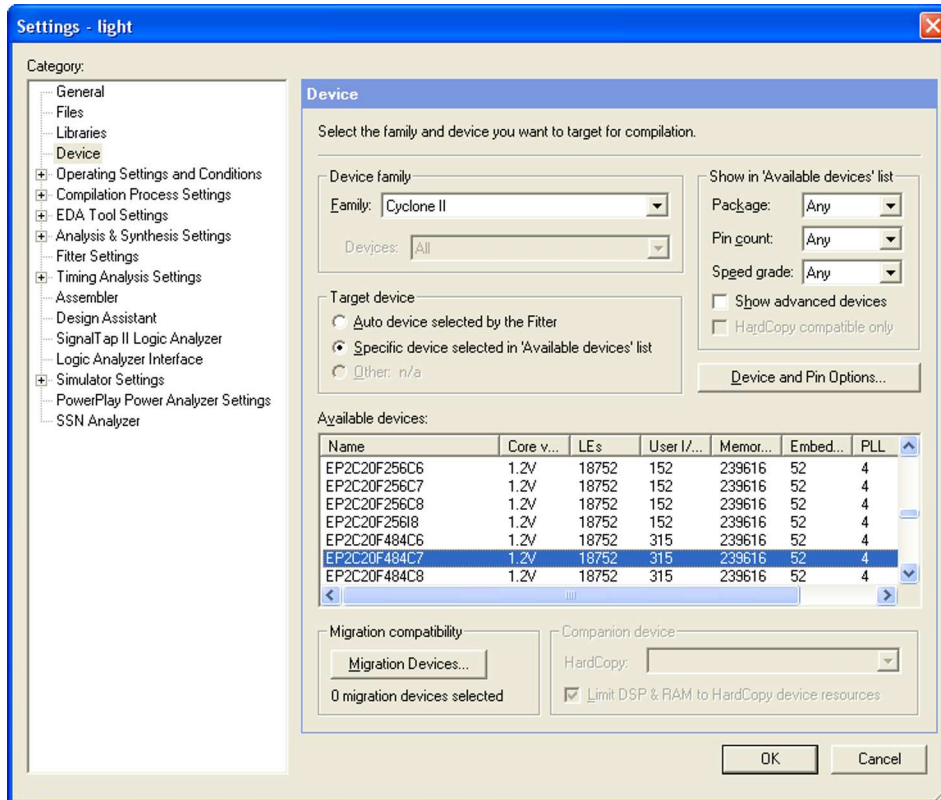

Figure 43. The Device Settings window.

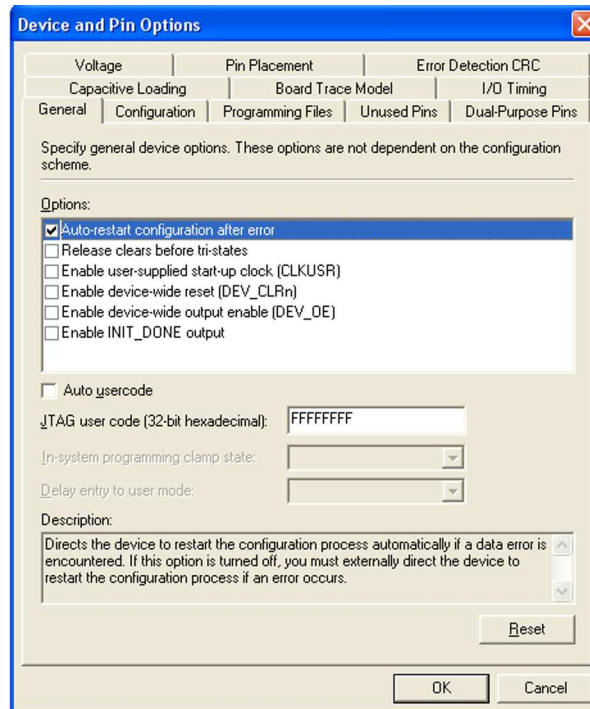

Figure 44. The Options window.

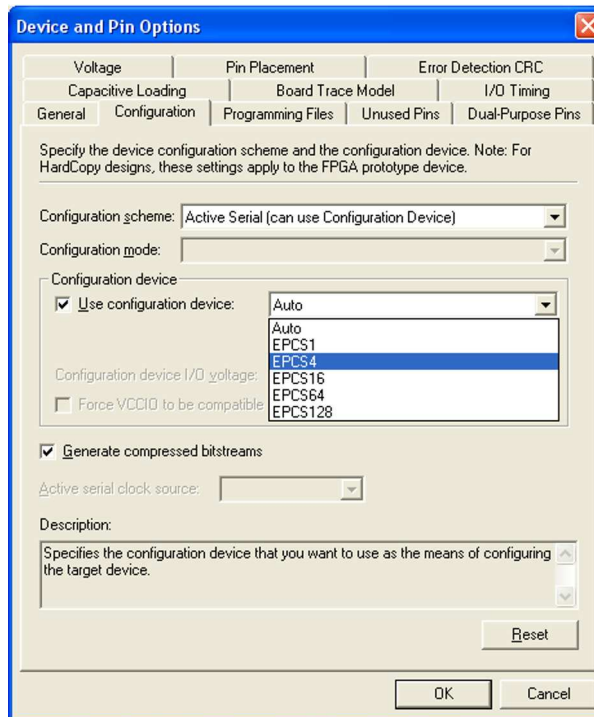

Figure 45. Specifying the configuration device.

The rest of the procedure is similar to the one described above for the JTAG mode. Select **Tools > Programmer** to reach the window in Figure 40. In the Mode box select **Active Serial Programming**. If you are changing the mode from the previously used JTAG mode, the pop-up box in Figure 46 will appear, asking if you want to clear all devices. Click **Yes**. Now, the Programmer window shown in Figure 47 will appear. Make sure that the Hardware Setup indicates the USB-Blaster. If the configuration file is not already listed in the window, press **Add File**. The pop-up box in Figure 48 will appear. Select the file *light.pof* in the directory *introtutorial* and click **Open**. As a result, the configuration file *light.pof* will be listed in the window. This is a binary file produced by the Compiler's Assembler module, which contains the data to be loaded into the EPCS4 configuration device. The extension *.pof* stands for Programmer Object File. Upon returning to the Programmer window, click on the **Program/Configure** check box, as shown in Figure 49.

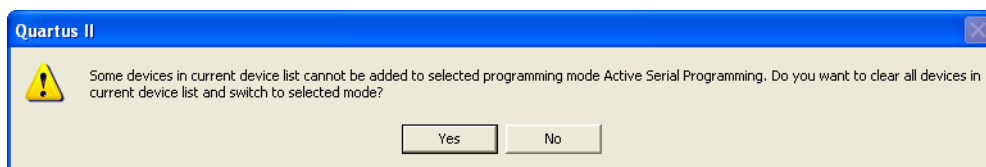

Figure 46. Clear the previously selected devices.

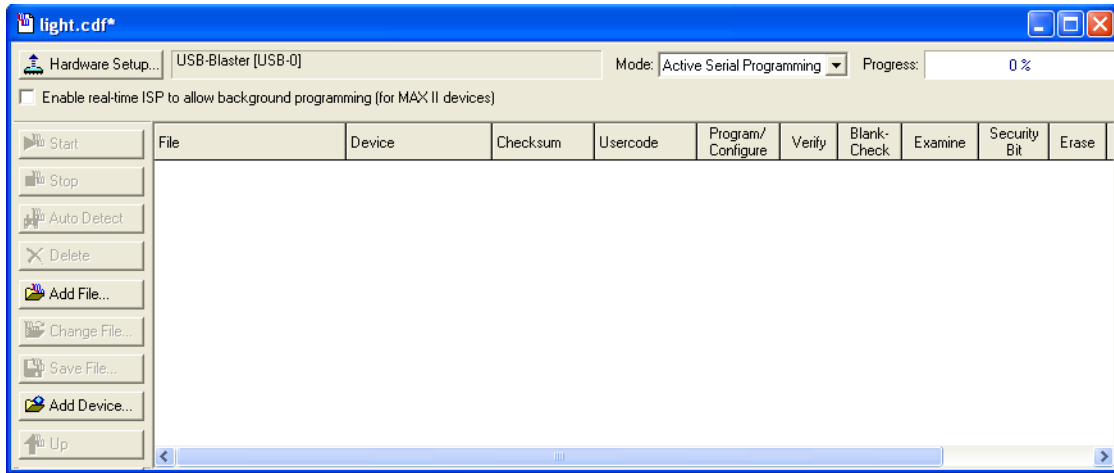

Figure 47. The Programmer window with Active Serial Programming selected.

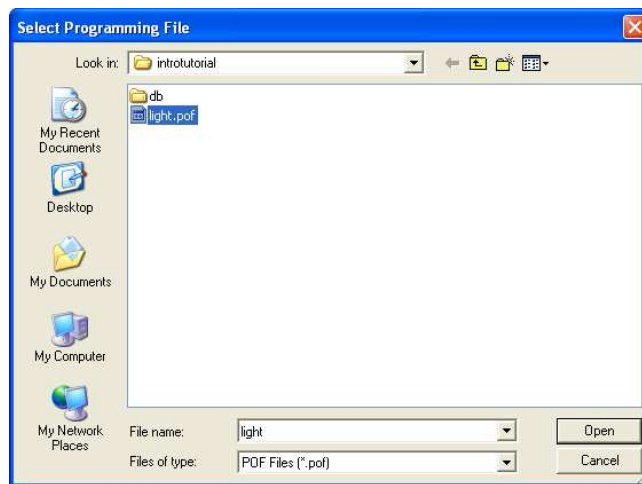

Figure 48. Choose the configuration file.

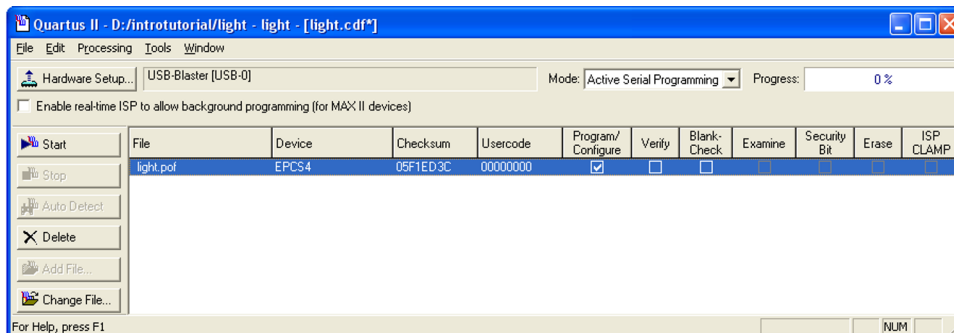

Figure 49. The updated Programmer window.

Flip the RUN/PROG switch on the DE1 board to the PROG position. Press **Start** in the window in Figure 49. An LED on the board will light up when the configuration data has been downloaded successfully. Also, the Progress box in Figure 49 will indicate when the configuration and programming process is completed, as shown in Figure 50.

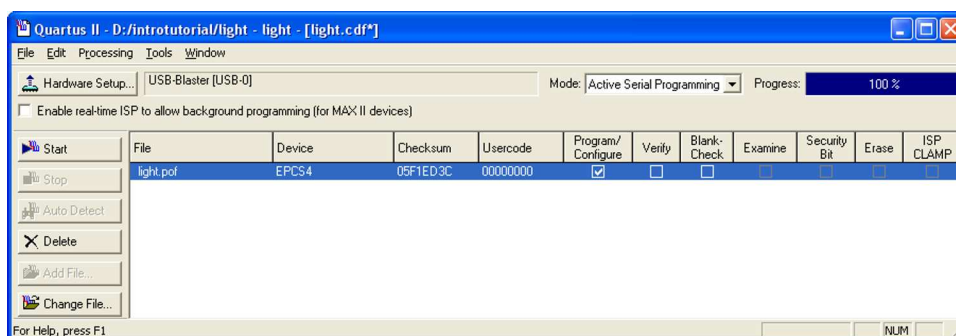

Figure 50. The Programmer window upon completion of programming.

8 Testing the Designed Circuit

Having downloaded the configuration data into the FPGA device, you can now test the implemented circuit. Flip the RUN/PROG switch to RUN position. Try all four valuations of the input variables x_1 and x_2 , by setting the corresponding states of the switches SW_1 and SW_0 . Verify that the circuit implements the truth table in Figure 11.

If you want to make changes in the designed circuit, first close the Programmer window. Then make the desired changes in the Block Diagram/Schematic file, compile the circuit, and program the board as explained above.

Copyright ©2009 Altera Corporation. All rights reserved. Altera, The Programmable Solutions Company, the stylized Altera logo, specific device designations, and all other words and logos that are identified as trademarks and/or service marks are, unless noted otherwise, the trademarks and service marks of Altera Corporation in the U.S. and other countries. All other product or service names are the property of their respective holders. Altera products are protected under numerous U.S. and foreign patents and pending applications, mask work rights, and copyrights. Altera warrants performance of its semiconductor products to current specifications in accordance with Altera's standard warranty, but reserves the right to make changes to any products and services at any time without notice. Altera assumes no responsibility or liability arising out of the application or use of any information, product, or service described herein except as expressly agreed to in writing by Altera Corporation. Altera customers are advised to obtain the latest version of device specifications before relying on any published information and before placing orders for products or services.

This document is being provided on an "as-is" basis and as an accommodation and therefore all warranties, representations or guarantees of any kind (whether express, implied or statutory) including, without limitation, warranties of merchantability, non-infringement, or fitness for a particular purpose, are specifically disclaimed.